

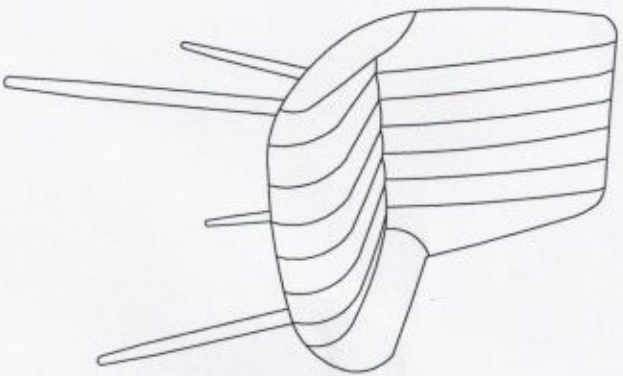

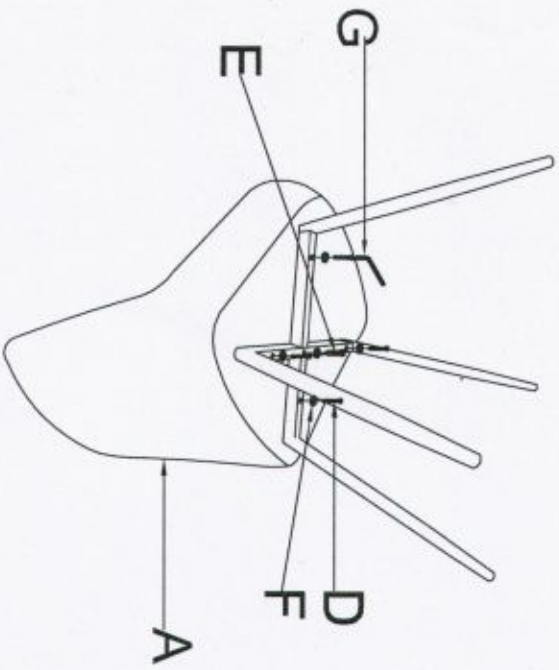

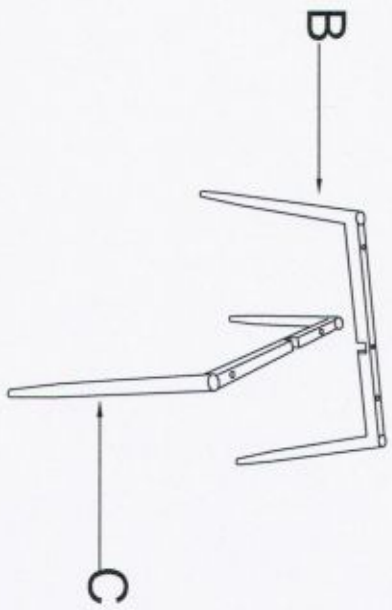



# ASSEMBLY INSTRUCTION



A		1	B		1
C		1	D		4
E		1	F		5
G		1			